

# LIFESTYLE

AUTUMN | WINTER 2025  
SPRING | SUMMER 2026

SUMMER SPECIALS FOLLOW



07/2025 - 07/2026

**Knirps**





**ΠΕΡΙΕΧΟΜΕΝΑ - INDEX**

**X4U - 6030 ( pages 5 ~ 7 )**

**U.Series ( pages 8 ~ 25 )**

- US.050 Ultra Light Slim Manual.....p. 8~13
- U.200 Ultra Light Duomatic.....p. 14~19
- U.090 Ultra Light XXL Manual Compact.....p. 20~22
- U.900 Ultra Light XXL Manual Long.....p. 23~25

**T.Series (pages 26 ~ 53)**

- T.020 Small Manual.....p. 26~28
- T.200 Medium Duomatic.....p. 29~35
- T.260 Medium Duomatic.....p. 36~38
- T.400 Extra Large Duomatic.....p. 39~42
- T.760 Stick Automatic.....p. 43~47
- T.771 Long Automatic.....p. 48~51
- T.900 Extra Long Automatic stick handle.....p. 52~53

**S.Series ( pages 54 ~ 59 )**

- S.570 Large Automatic.....p. 54~56
- S.770 Long Automatic.....p. 57~59

**Vision - 6205 ( pages 60 ~ 61 )**

**A.Series ( pages 62 ~ 84 )**

- A.050 Medium Manual.....p. 62~67
- A.200 Medium Duomatic.....p. 69~74
- A.400 XXL Duomatic.....p. 75~76
- A.405 XXL Duomatic Vented.....p. 77~78
- A.760 Stick Automatic.....p. 79~81
- A.771 Stick Automatic.....p. 82~84

**C.Series ( pages 85 ~ 87 )**

- C.760 Stick Transparent.....p. 85~87

**X1 - 6010 ( pages 88 ~ 89 )**

**Accessories ( page 90)**



**KNIRPS. ΒΙΩΣΙΜΗ ΑΠΟ ΤΗΝ ΑΡΧΗ.  
KNIRPS. SUSTAINABLE FROM THE VERY BEGINNING.**

Η Knirps προσφέρει πολύτιμα και βιώσιμα προϊόντα υψηλής ποιότητας για πάνω από 95 χρόνια. Παράλληλα με τη συνεπή επωνυμία και την καινοτόμο ανάπτυξη προϊόντων, εστιάζουμε στη σύγχρονη περιβαλλοντική προστασία. Η σφραγίδα **CRS** το κάνει αυτό σαφές & διαφανές για όλους:

**SAVE (ΕΞΟΙΚΟΝΟΜΗΣΗ):** Τα εξαρτήματα όλων των ομπρελών της Knirps επιλέγονται με γνώμονα την προστασία του περιβάλλοντος. Η προηγμένη μηχανική και ο διαχρονικός σχεδιασμός καθιστούν κάθε Knirps έναν πιστό σύντροφο στον ήλιο και τη βροχή.

**REPAIR (ΕΠΙΣΚΕΥΗ):** Επισκευάζουμε και διαφυλλάσσουμε τον πλανήτη μας μακροπρόθεσμα. Όποτε χρειαστεί, φέρτε μας την ομπρέλα σας Knirps στα εξειδικευμένα εργαστήριά μας, όπου επισκευάζουμε με αγάπη τα παλαιά προϊόντα Knirps για δεκαετίες.

**CARE (ΦΡΟΝΤΙΔΑ):** Τα προϊόντα και οι εγκαταστάσεις μας έχουν ελεγχθεί από εξωτερικά πιστοποιημένα ιδρύματα, όπως το TÜV ή το BSCI, για δεκαετίες, σύμφωνα με κοινωνικά πρότυπα, ποιότητα προϊόντων και περιβαλλοντική προστασία.

Knirps has offered valuable and sustainable quality products for over 95 years.

Alongside consistent branding and innovative product development, we are focused on modern environmental protection. The CRS seal makes this transparent for all:

**SAVE:** The components of all Knirps umbrellas are selected with environmental protection in mind. Sophisticated engineering and timeless design make every Knirps a longtime companion in the sun and rain.

**REPAIR:** We have been repairing and preserving our planet for the long run. Whenever necessary, bring your Knirps to our expert workshops, where we have been repairing old Knirps products with love for decades.

**CARE:** Our products and facilities have been verified by external certified institutes such as the TÜV or BSCI for decades according to social standards, product quality, and environmental protection.



**ΔΟΚΙΜΑΖΟΥΜΕ ΓΙΑ ΤΟΥΣ ΠΕΛΑΤΕΣ ΜΑΣ!**

Όλα τα προϊόντα Knirps υποβάλλονται σε αυστηρές δοκιμές αντοχής και διάρκειας ζωής. Θέτουμε τα δικά μας αυστηρά πρότυπα για κάθε σειρά προϊόντων σχετικά με τη λειτουργία duomatic (μηχανισμός ανοίγματος / κλεισίματος) αλλά και την αναστροφή (όταν ο άνεμος αναποδογυρίζει την ομπρέλα).

**WE TEST FOR OUR CUSTOMERS!**

All Knirps products are subjected to stringent stress and durability tests. We set our own standards for each product series regarding duomatic function (open/close mechanism) and flipping (when the wind blows an umbrella inside out).

	<b>ΛΕΙΤΟΥΡΓΙΑ ΑΝΟΙΓΜΑΤΟΣ/ΚΛΕΙΣΙΜΑΤΟΣ OPEN/CLOSE FUNCTION</b>	<b>ΑΝΑΣΤΡΟΦΗ FLIP OVER</b>
T.Series	1000x	300x
S.Series	1000x	-
U.Series	700x	200x
A.Series	500x	150x

Από την 01.01.2021 ισχύει εγγύηση 5 ετών για όλη τη γκάμα προϊόντων Knirps. Δεν απαιτείται online εγγραφή. Απλώς κρατήστε την απόδειξη.

From 01.01.2021 there are 5 years warranty on the entire Knirps product range. No online registration necessary. Just keep the receipt.



**Knirps....** η ομπρέλα με την κόκκινη τελεία ●

**Knirps....** the umbrella with the red dot ●

X4U

# X4U MANUAL

Κωδικός: 95 6030



WARRANTY



WINDPROOF



100 km/h



DRY CASE



Αξονας σπαστός σε 3 μέρη / 3-part alushaft

Ακτίνες 3 μερών από αλουμίνιο & υαλονήματα / 3-part ribs made of aluminium and fibreglass



90 cm  
35.4 in



21 cm  
8.3 in



115 g  
4.06 oz



49 cm  
19.3 in



48 cm  
18.9 in



6 ακτίνες

6 ribs

Επιστροφή - Περιεχόμενα

Return to Index



95 6030 1001 | BLACK



95 6030 1201 | NAVY



95 6030 8800 | NEON YELLOW



95 6030 8801 | NEON ORANGE



95 6030 8802 | NEON PINK

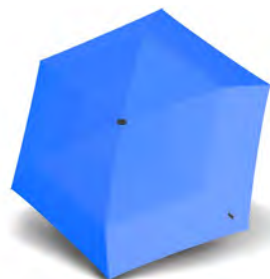

95 6030 8803 | NEON BLUE



NEW

95 6030 8851 | SESAME

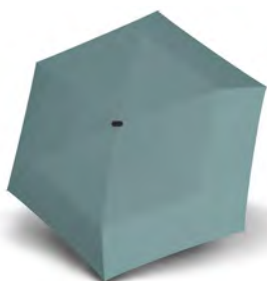

NEW

95 6030 8852 | LAKE



NEW

95 6030 8853 | OLIVE

FASHION FASHION FASHION



FASHION

95 6030 8854 | FURRY



# US.050 ULTRA LIGHT SLIM MANUAL

Κωδικός: 95 0050



PREMIUM



WARRANTY



WINDPROOF



100 km/h

**ULTRA LIGHT**  
**ULTRA SLIM**  
**ULTRA STRONG**



reddot winner 2020

Αξονας σπαστός σε 3 μέρη / 3-part alushaft

Ακτίνες 3 μερών από αλουμίνιο & υαλονήματα / 3-part ribs made of aluminium and fibreglass



90 cm  
35.4 in



21 cm  
8.3 in



115 g  
4.06 oz



49 cm  
19.3 in



48 cm  
18.9 in



6 ακτίνες

6 ribs





Η ελαφρύτερη Knirps – εξαιρετικά ανθεκτική με βάρος μόλις 115 gr!

The lightest Knirps – ultra sturdy at only 115 gr!



Συσκευάζεται εξαιρετικά μικρή και επίπεδη: χωράει σε κάθε τσάντα.

Packs up ultra small, ultra flat: fits in any bag



Εξαιρετικά ανθεκτικό μείγμα υλικών από αλουμίνιο και υαλονήματα – δοκιμασμένο σε αεροσήραγγα με ανέμους έως 100 km/h.

Ultra sturdy material mix of aluminium and fibreglass – tested up to 100 km/h in a wind tunnel



95 0050 1001 | BLACK



95 0050 1201 | NAVY



95 0050 0801 | DARK GREY



95 0050 2701 | GREEN



95 0050 1501 | RED



95 0050 1702 | BERRY



95 0050 8393 | NEON PINK



95 0050 8394 | NEON GREEN

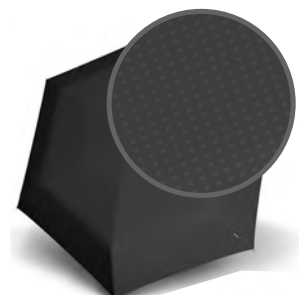

95 0050 1100 | MAT CROSS



95 0050 8472 | RAIN BLACK

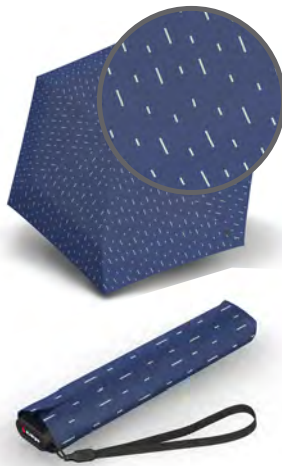

95 0050 8473 | RAIN BLUE



95 0050 8670 | RAINYDAY BLACK



95 0050 8705 | THINK



95 0050 8706 | TROPICAL

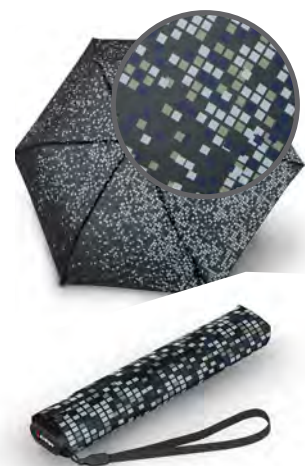

95 0050 8804 | BRAVE



95 0050 8814 | STORY BLACK



95 0050 8815 | STORY SEA



95 0050 8817  
SAKURA ROMANCE

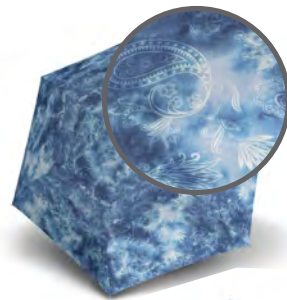

NEW



NEW



95 0050 8849 | KOLIBRI

95 0050 8850 | PAISLEY

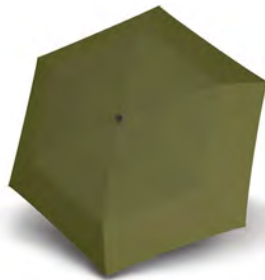
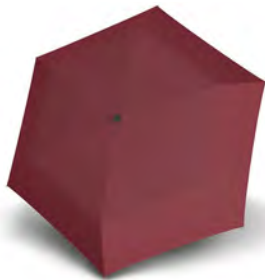

NEW



NEW



NEW



95 0050 8846 | BORDEAUX

95 0050 8847 | CARDAMON

95 0050 8848 | PLUM

HEATSHIELD -40%



HEATSHIELD



HEATSHIELD



95 0050 1800 | ROSE WITH BLACK COATING

95 0050 2200 | BLUE WITH BLACK COATING



-29%



95 0050 1009 | BLACK WITH ROSE COATING

95 0050 1340 | TURQUOISE WITH BLACK COATING



NEW

NEW



95 0050 10012 | BLACK WITH BLACK COATING

95 0050 12012 | NAVY WITH BLACK COATING



NEW

NEW



95 0050 88462 | BORDEAUX WITH BLACK COATING

95 0050 88482 | PLUM WITH BLACK COATING

U.SERIES

# U.200 ULTRA LIGHT DUOMATIC

Κωδικός: 95 2200



PREMIUM



WARRANTY



WINDPROOF



120 km/h

**ULTRA LIGHT**  
**ULTRA SLIM**  
**ULTRA STRONG**



reddot winner 2020

Αξονας σπαστός σε 3 μέρη / 3-part alushaft

Ακτίνες 3 μερών από αλουμίνιο & υαλονήματα / 3-part ribs made of aluminium and fibreglass



95 cm  
37.4 in



27 cm  
10.6 in



180 g  
6.35 oz



54 cm  
21.3 in



53 cm  
20.9 in



6 ακτίνες

6 ribs

Επιστροφή - Περιεχόμενα

Return to Index



Η ελαφρύτερη Knirps Duomatic. Εξαιρετικά ανθεκτική με βάρος μόλις 180 gr!

The lightest Knirps Duomatic – ultra sturdy at only 180 gr!



Μεγάλο κουμπί για το πάτημα για μεγαλύτερη άνεση

Large push-button for optimal comfort



Εξαιρετικά ανθεκτικό μείγμα υλικών από αλουμίνιο και υαλονήματα δοκιμασμένο σε αεροσήραγγα με ανέμους έως 120 km/h.

Ultra strong material mix of aluminium and fibreglass tested up to 120 km/h in a wind tunnel

U.SERIES

U.200 ULTRA LIGHT DUOMATIC



95 2200 1001 | BLACK



95 2200 1201 | NAVY



95 2200 0801 | DARK GREY



95 2200 1401 | AQUA



95 2200 1501 | RED



95 2200 1702 | BERRY

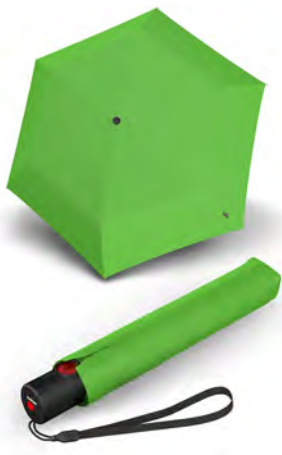

95 2200 2701 | GREEN



95 2200 8393 | NEON PINK



95 2200 8394 | NEON GREEN

RE<sup>3</sup>

U.SERIES

T.SERIES

S.SERIES

A.SERIES

CONCEPT

POS

INFORMATION





95 2200 1800 | ROSE WITH BLACK COATING



95 2200 2200 | BLUE WITH BLACK COATING



95 2200 8670 | RAINYDAY BLACK

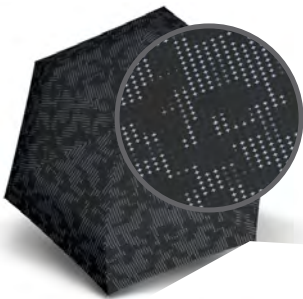

95 2200 8705 | THINK



95 2200 8706 | TROPICAL



95 2200 8707 | HEAVEN



95 2200 8705 | THINK



95 2200 8706 | TROPICAL



95 2200 8707 | HEAVEN

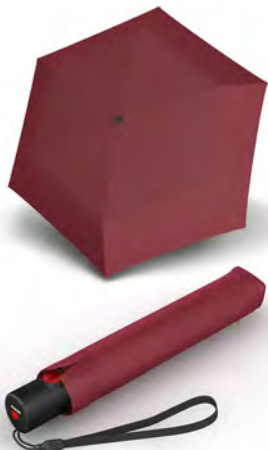

95 2200 8846 | BORDEAUX

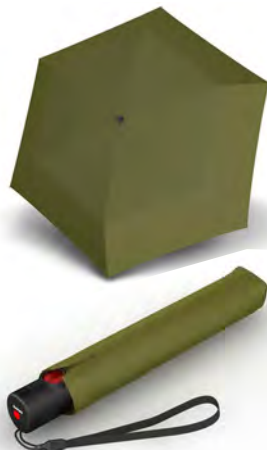

95 2200 8847 | CARDAMON

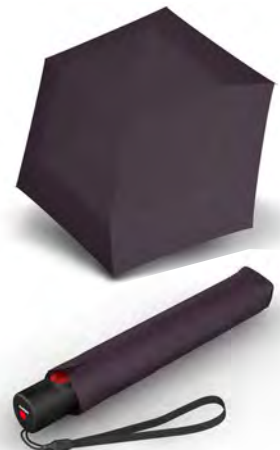

95 2200 8848 | PLUM



95 2200 88052 | VANILLA WITH IRIDISCENT COATING



95 2200 88062 | MINT WITH IRIDISCENT COATING



95 2200 88072 | PEACH WITH IRIDISCENT COATING



**UV PROTECTION**

Εξαιρετική προστασία από βροχή και ήλιο. Αποκλείει τουλάχιστον το 95% της ακτινοβολίας UVA και το 98% της UVB. Δοκιμασμένο σύμφωνα με το αυστραλο-νεοζηλανδικό πρότυπο AS/NZS 4033:2017.

Outstanding protection from rain and sun. Blocks at least 95% of UVA and 98% of UVB rays. Tested in accordance with Australia/New Zealand norm AS/NZS 4033:2017

**UV95  
UPF50**

**HEAT SHIELD**

Χάρη στην εσωτερική επίστρωση, οι ομπρέλες προσφέρουν μέγιστη προστασία από την υπεριώδη ακτινοβολία (UV) με επιπλέον προστασία από τη θερμότητα, καθώς η θερμοκρασία κάτω από την ομπρέλα μειώνεται έως και κατά 40%. Το Heat Shield μπλοκάρει περισσότερο από το 99,95% των ακτίνων UVA και παρέχει εξαιρετική αντηλιακή προστασία με SPF / UPF 50+.

Thanks to the coating on the inside, the umbrellas offer maximum UV protection with additional heat protection, as the temperature under the canopy is reduced by up to 40%. The Heat Shield blocks more than 99.95% of UVA rays and has excellent sun protection at SPF / UPF 50+.



**HEAT  
SHIELD**



HEATSHIELD

95 2200 1800 | ROSE WITH BLACK COATING



HEATSHIELD

95 2200 2200 | BLUE WITH BLACK COATING



95 2200 1009 | BLACK WITH ROSE COATING



95 2200 1340 | TURQUOISE WITH BLACK COATING



95 2200 10012 | BLACK WITH BLACK COATING



95 2200 12012 | NAVY WITH BLACK COATING



95 2200 87042 | FOREST WITH BLACK COATING



95 2200 87112 | MAUVE WITH BLACK COATING

# U.090 ULTRA LIGHT XXL MANUAL COMPACT

Κωδικός: 95 2090



PREMIUM



WARRANTY



WINDPROOF



120 km/h



**ULTRA LIGHT**  
**ULTRA BIG**  
**ULTRA STRONG**

Αξονας σπαστός σε 3 μέρη / 3-part alushaft

Ακτίνες 3 μερών από αλουμίνιο & υαλονήματα / 3-part ribs made of aluminium and fibreglass



126 cm  
49.6 in



38 cm  
15 in



295 g  
10.41 oz



69 cm  
27.2 in



76 cm  
29.9 in



8 ακτίνες

8 ribs



Εξαιρετικά ελαφριά αναδιπλούμενη ομπρέλα για δύο άτομα, με υπερμεγέθη θόλο διαμέτρου 126 cm.

Ultra light folding umbrella for two people, with oversize canopy (126 cm diameter)



Εξαιρετικά συμπαγής ομπρέλα για τσάντες και σακίδια με βάρος μόλις 295 gr.

Ultra compact umbrella for handbags and backpacks with a weight of only 295 gr

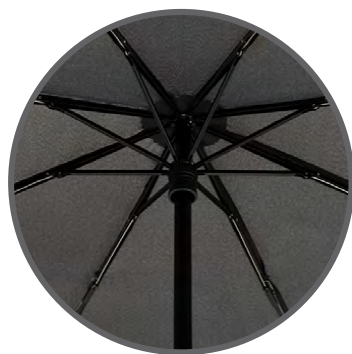

Εξαιρετικά ανθεκτική ελαφριά κατασκευή από πλαστικό ενισχυμένο με ανθρακονήματα και αλουμίνιο, δοκιμασμένη σε αεροσήραγγα με ανέμους έως 100 km/h.

Ultra strong lightweight construction made of fiber reinforced plastic and aluminium tested up to 100 km/h in the wind tunnel



95 2090 1001 | BLACK



95 2090 1702 | BERRY



95 2090 0801 | DARK GREY



95 2090 1201 | NAVY

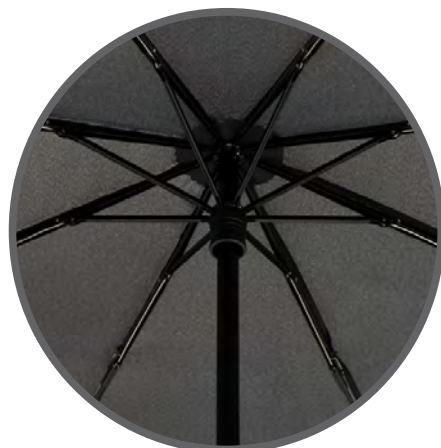

U.SERIES

# U.900 ULTRA LIGHT XXL MANUAL

Κωδικός: 96 2900



CarboFlex®



PREMIUM



WARRANTY



WINDPROOF



120 km/h

**ULTRA LIGHT**  
**ULTRA BIG**  
**ULTRA STRONG**



Σκελετός από αλουμίνιο / aluminium shaft  
Ακτίνες από ανθρακονήματα / carbon ribs



133 cm  
52.4 in



97 cm  
38.2 in



245 g  
8.64 oz



74 cm  
29.1 in



90 cm  
35.4 in



8 ακτίνες

8 ribs

Επιστροφή - Περιεχόμενα

Return to Index



Η ελαφρύτερη ομπρέλα συντροφιάς της Kniprs. Εξαιρετικά ελαφριά με βάρος μόλις 245 gr

The lightest partner umbrella from Kniprs – Ultra light with only 245 gr

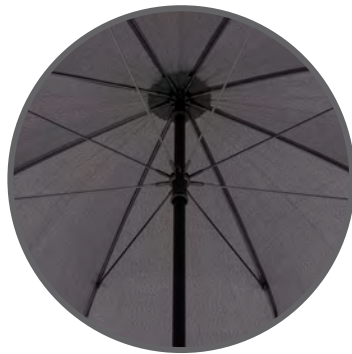

Υπερμεγέθους θόλος με διάμετρο 133 cm.

Ultra large canopy with 133 cm diameter

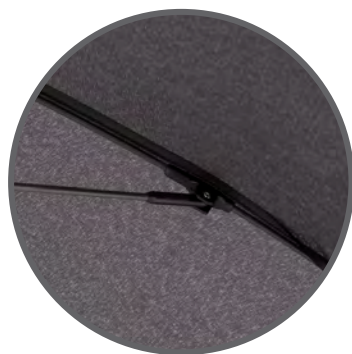

Εξαιρετικά ανθεκτική ελαφριά κατασκευή από ανθρακονήματα και αλουμίνιο, δοκιμασμένη σε αεροσήραγγα με ανέμους έως 120 km/h.

Ultra strong lightweight construction made of carbon and aluminium tested up to 120 km/h in the wind tunnel





96 2900 1001 | BLACK



96 2900 1201 | NAVY



96 2900 0801 | DARK GREY



96 2900 8393 | NEON PINK



96 2900 8394 | NEON GREEN



96 2900 1702 | BERRY

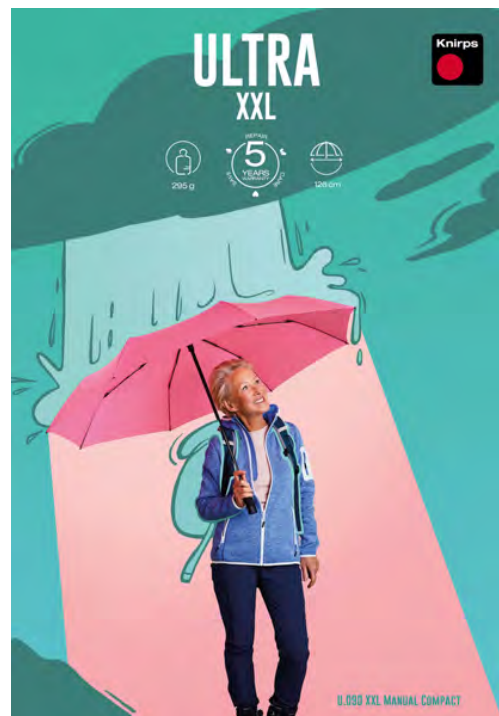

T.SERIES

# T.020 SMALL MANUAL

Κωδικός: 95 3020



PREMIUM



WARRANTY



WINDPROOF



120 km/h



Αξονας αλουμινίου σπαστός σε 3 μέρη / 3-part alushaft

Ακτίνες 3 μερών από ατσάλι & υαλονήματα / 3-part ribs made of aluminium and fibreglass



94 cm  
37.0 in



19 cm  
7.5 in



245 g  
8.64 oz



51 cm  
20.1 in



51 cm  
20.1 in



7 ακτίνες

7 ribs

Επιστροφή - Περιεχόμενα

Return to Index



Πολύ φιλική προς τον χρήστη – η ομπρέλα μπορεί να διπλωθεί και να αποθηκευτεί μέσα σε λίγα δευτερόλεπτα.

Very user-friendly – umbrella can be folded and stowed in a few seconds



Πολύ μεγάλο σκίαστρο με μικρό, συμπαγές μέγεθος συσκευασίας.

Very large canopy with a small, compact pack size



Εξαιρετικά ανθεκτικός άξονας από αλουμίνιο αεροσκαφών με παχύτερα τοιχώματα.

Extremely robust shaft made of aircraft aluminum with thicker walls

T.SERIES



95 3020 1000 | BLACK



95 3020 1200 | NAVY



UV95IUPF50

95 3020 1510 | DARK RED



95 3020 0800 | DARK GREY



RE<sup>3</sup>

U.SERIES

T.SERIES

S.SERIES

A.SERIES

CONCEPT

POS

INFORMATION

# T.200 MEDIUM DUOMATIC

Κωδικός: 95 3201



PREMIUM



WARRANTY



WINDPROOF



150 km/h



Τέστ σε αεροσήραγγα  
windtunnel test

95 3201

Μαύρος Αξονας από αλουμίνιο & ασάλι σπαστός σε 3 μέρη / black 3-part shaft made of aluminium and steel  
Ακτίνες 3 μερών από αλουμίνιο & υαλονήματα / 3-part ribs made of aluminium and fibreglass



97 cm  
38.2 in



28 cm  
11.0 in



330 g  
11.64 oz



54 cm  
21.3 in



55 cm  
21.7 in



8 ακτίνες

8 ribs



Αυτόματη λειτουργία ανοίγματος/κλεισίματος με ελάχιστη πίεση για τη διευκόλυνσή σας.

Smooth duomatic open/close function for your convenience



Παγκόσμιο bestseller, σχεδιασμένη με ακρίβεια και κατασκευασμένη από τα υψηλότερης ποιότητας εξαρτήματα.

Worldwide bestseller, designed with precision and made from the highest-quality components

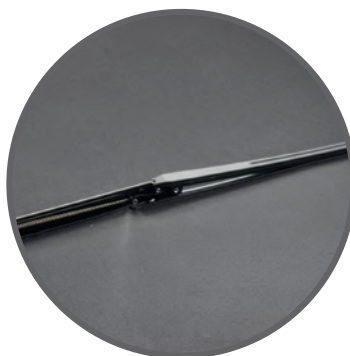

Μείγμα υψηλής ποιότητας υλικών για μέγιστη σταθερότητα, δοκιμασμένη σε αεροδυναμική σήραγγα με ταχύτητες ανέμου έως 150 km/h.

High-quality material mix for maximum stability tested up to 150 km/h in a wind tunnel



95 3201 1000 | BLACK



95 3201 1200 | NAVY



95 3201 1500 | RED



95 3201 4119 | MELANGE BLACK



95 3201 4900 | BORDEAUX



95 3201 8808 | FOG



95 3201 8809 | ROOBOS



95 3201 8810 | LAGOON

T.200 MEDIUM DUOMATIC | NOS



95 3201 5181  
CHECK HUNTER



95 3201 5191  
CHECK RED'N NAVY



95 3201 5290  
CHECK BLACK



95 3201 7602  
MEN'S PRINTS CHECK

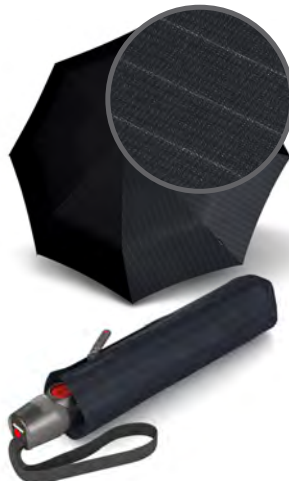

95 3201 7603  
MEN'S PRINTS STRIPE



95 3201 5390 | CHECK BEIGE

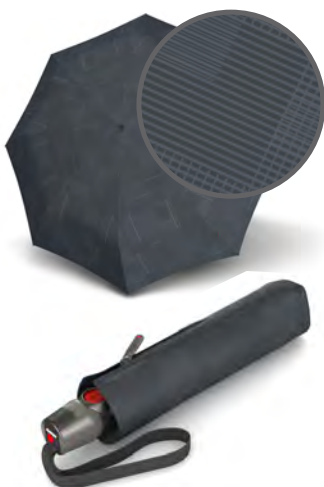

95 3201 8433  
CHALLENGE BLACK



95 3201 8434  
CHALLENGE BLUE



95 3201 5990 | CHECK NAVY

RE<sup>3</sup>

U.SERIES

T.SERIES

S.SERIES

A.SERIES

CONCEPT

POS

INFORMATION





95 3201 8620  
VIBRATION MAGMA



95 3201 8628 | MERMAID



95 3201 8629 | BLOOMING



95 3201 8630  
DREAMING



95 3201 8687 | ETERNITY



95 3201 8695  
SYMPHONY CHOCOLATE



95 3201 8696 | AQUARIUS



95 3201 8778 | GARDEN EARTH



95 3201 8779 | GARDEN SCARLET



95 3201 8783  
PALM MULTICOLOR



95 3201 8784 | PALM STORM



NEW

95 3201 8823 | JAMAICA



UV95IUPF

95 3201 8785 | BOTANY SHELL



UV95IUPF50

95 3201 8786 | BOTANY OLIV



UV95IUPF50

95 3201 8787 | BOTANY SEA



NEW

95 3201 8833 | LIANA NATURE



NEW

95 3201 8834 | LIANA ROSEWOOD



NEW

95 3201 8835 | LIANA SKY

RE3

U.SERIES

T.SERIES

S.SERIES

A.SERIES

CONCEPT

POS

INFORMATION



NEW

NEW

NEW



95 3201 8826 | PEACOCK RED

95 3201 8827 | PEACOCK GREEN

95 3201 8825 | RIBBON

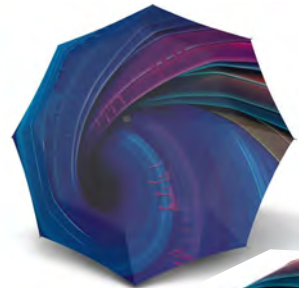
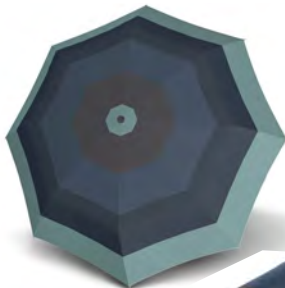
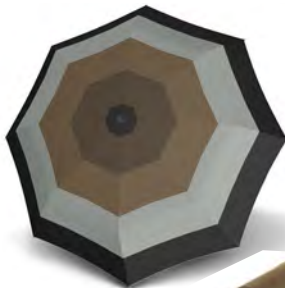

NEW

NEW

NEW



95 3201 8828  
CLASSICS BLACK

95 3201 8829  
CLASSICS BLUE

95 3201 8824 | TORNADO



NEW

NEW

NEW



95 3201 8830 | TIGER BLUE

95 3201 8831 | TIGER OAK

95 3201 8832 | TIGER SKY

T.SERIES

# T.260 MEDIUM DUOMATIC

Κωδικός : 95 3260



PREMIUM



WARRANTY



WINDPROOF



150 km/h



Αξονας από αλουμίνιο & ατσάλι σπαστός σε 3 μέρη / black 3-part shaft made of aluminium and steel  
Ακτίνες 3 μερών από αλουμίνιο & υαλονήματα / 3-part ribs made of aluminium and fibreglass



96 cm  
37.8 in



32 cm  
12.6 in



400 g  
14.11 oz



54 cm  
21.3 in



59 cm  
23.2 in



8 ακτίνες

8 ribs

Επιστροφή - Περιεχόμενα

Return to Index



Κομψή γυριστή λαβή με διαφορετικές υφές επιφάνειας για πιο ευχάριστη αίσθηση.

Stylish crook handle with different surface structures for pleasant feel



Δοκιμασμένη σε άνεμο έως 150 km/ώρα σε αεροσήραγα χάρη στις ακτίνες με πλαστικούς συνδέσμους.

Tested up to 150 km/h in a wind tunnel thanks to stretchers with plastic joints



Εξαιρετικά ανθεκτικός άξονας από ατσάλι και αλουμίνιο.

Super-strong steel and aluminium shaft



95 3260 1000 | BLACK

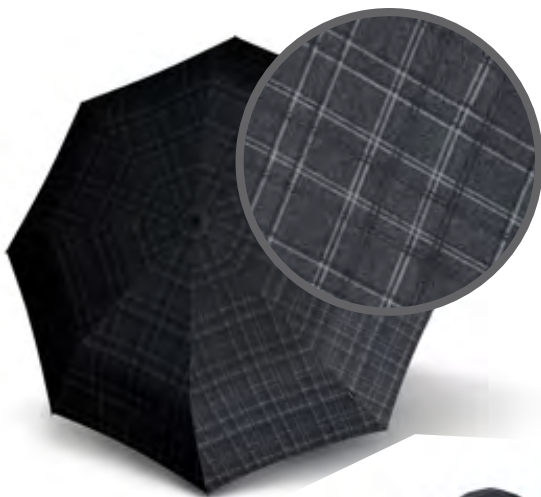

95 3260 7602  
MEN'S PRINTS CHECK

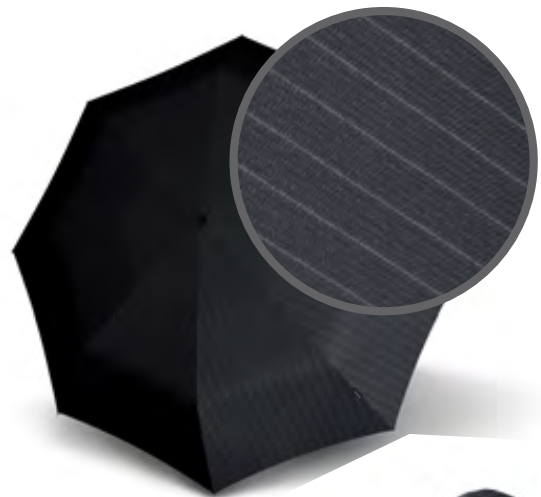

95 3260 7603  
MEN'S PRINTS STRIPE

T.SERIES

# T.400 EXTRA LARGE DUOMATIC

Κωδικός: 95 3400



PREMIUM



WARRANTY



WINDPROOF



120 km/h



Αξονας από ασάλι σπαστός σε 3 μέρη / 3-part steelshaft

Ακτίνες 3 μερών από ασάλι, πολυαμίδιο & υαλονημάτα / 3-part ribs made of steel, polyamid and fibreglass



115 cm  
45.3 in



35 cm  
13.8 in



590 g  
20.81 oz



64 cm  
25.2 in



70 cm  
27.6 in



8 ακτίνες

8 ribs

Επιστροφή - Περιεχόμενα

Return to Index



Υπερμεγέθης θόλος σε πτυσσόμενη ομπρέλα.

Oversized canopy in a folding umbrella



Εξαιρετικά μεγάλη εργονομική λαβή για άνετη μεταφορά.

Extra-large ergonomic handle for carrying comfort

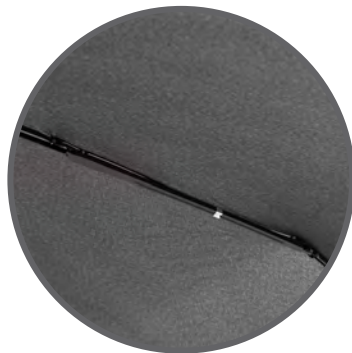

Ειδικό μείγμα πλαστικού στις ακτίνες εξασφαλίζει ιδανικό βάρος, ανθεκτικότητα και μακροχρόνια διάρκεια.

Special plastic blend on the stretchers ensures optimal weight, sturdiness and durability



T.400 EXTRA LARGE DUOMATIC

RE<sup>3</sup>

U.SERIES

T.SERIES

S.SERIES

A.SERIES

CONCEPT

POS

INFORMATION



95 3400 1000 | BLACK



95 3400 1200 | NAVY



95 3400 7602  
MEN'S PRINTS CHECK

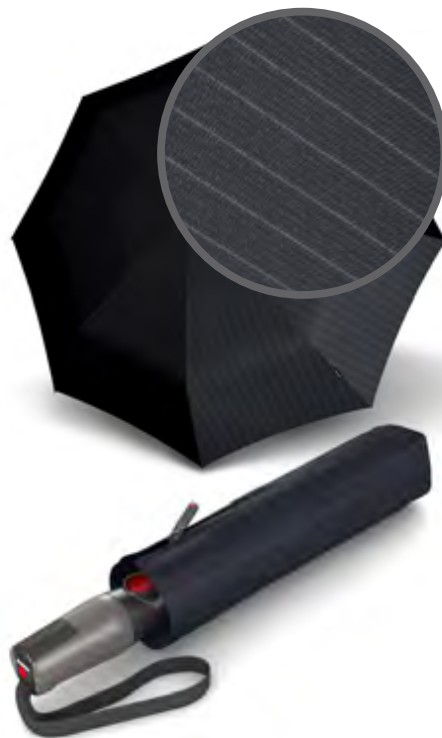

95 3400 7603  
MEN'S PRINTS STRIPE



T.SERIES

# T.760 STICK AUTOMATIC

Κωδικός : 96 3760



PREMIUM



WARRANTY



WINDPROOF



80 km/h



Ατσάλινος άξονας & ακτίνες από υαλονήματα / Steel shaft and fibreglass rib



105 cm  
41.3 in



88 cm  
34.6 in



460 g  
16.23 oz



60 cm  
23.6 in



77 cm  
30.3 in



8 ακτίνες

8 ribs

Επιστροφή - Περιεχόμενα

Return to Index



Κλασική μακριά ομπρέλα με μηχανισμό αυτόματου ανοίγματος.

Classic stick umbrella with automatic opening mechanism



Ανθεκτικότητα χάρη σε προσεκτικά επιλεγμένα υλικά.

Durability by carefully selected materials



Λεπτή βερνικωμένη γυριστή λαβή και διακριτικό λογότυπο Knirps.

Finely varnished crook handle with discrete Knirps logo

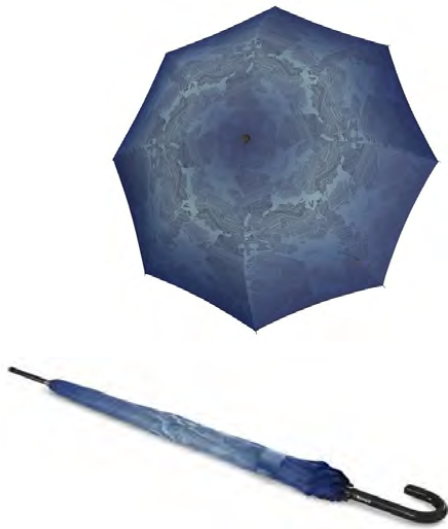

3760 8421 | MIRACLE SKY



3760 8419 | MIRACLE EARTH



ecorepel<sup>®</sup>  
A water repellent technology

PFC FREE  
ENVIRONMENTALLY FRIENDLY



ecorepel<sup>®</sup>  
A water repellent technology

PFC FREE  
ENVIRONMENTALLY FRIENDLY



ecorepel<sup>®</sup>  
A water repellent technology

PFC FREE  
ENVIRONMENTALLY FRIENDLY

CLEAR

3760 8549 | CLEAR SKY

3760 8550 | CLEAR STONE

3760 8551 | CLEAR FIRE



HEAT SHIELD -40%  
UVA 95% | UVB 98%  
UPF 50+



HEAT SHIELD -40%  
UVA 95% | UVB 98%  
UPF 50+



HEAT SHIELD -40%  
UVA 95% | UVB 98%  
UPF 50+

FEEL

3760 8556 | FEEL LAPIS WITH UV COATING

3760 8557 | FEEL JADE WITH UV COATING

3760 8558 | FEEL PURPLE WITH UV COATING



96 3760 8628 | MERMAID





96 3760 8629 | BLOOMING



T.SERIES

# T.771 LONG AUTOMATIC

Κωδικός : 96 3773



PREMIUM



STEEL



WARRANTY



WINDPROOF



80 km/h



Αξονας από ασάλι & ακτίνες από υαλονήματα / Steel shaft and black fiberglass ribs



111 cm  
43.7 in

· 56 ·



90 cm  
35.4 in



590 g  
20.81 oz



63 cm  
24.8 in



81 cm  
31.9 in



10 ακτίνες

10 ribs

· 48 ·

RE<sup>3</sup>

U.SERIES

T.SERIES

S.SERIES

A.SERIES

CONCEPT

POS

INFORMATION

Επιστροφή - Περιεχόμενα

Return to Index





Υπερμεγέθης, κομψή ομπρέλα  
με 10 ακτίνες.

Oversized, elegant canopy with 10  
ribs



Ανθεκτική κατασκευή με πιστοποιημένο  
ασάλινο άξονα και ακτίνες από ελαφριές  
και εύκαμπτες υαλοΐνες (fiberglass)

Robust construction with proven  
steel shaft and ribs made of light-  
weight and flexible fiberglass



Γυριστή λαβή από Καναδικό  
ξύλο σφενδάμου

Crook handle made of Canadian  
maple wood



96 3773 1000 | BLACK



96 3773 7602  
MEN'S PRINTS CHECK



96 3773 7603  
MEN'S PRINTS STRIPE



3773 8433  
CHALLENGE BLACK



T.SERIES

# T.900 EXTRA LONG AUTOMATIC STICK HANDLE

Κωδικός : 96 3900



PREMIUM



WARRANTY



WINDPROOF



90 km/h



Αξονας από ασάλι & ακτίνες από υαλονήματα / Steel shaft and black fiberglass ribs



120 cm  
47.2 in



95 cm  
37.4 in



680 g  
23.99 oz



69 cm  
27.1 in



85 cm  
33.5 in



8 ακτίνες

8 ribs

Επιστροφή - Περιεχόμενα

Return to Index

RE<sup>3</sup>

U.SERIES

T.SERIES

S.SERIES

A.SERIES

CONCEPT

POS

INFORMATION



Μεγάλη ομπρέλα για δύο άτομα με κομψή θήκη για βέλτιστη προστασία.

Large partner umbrella with elegant sleeve for optimal protection



Εύκαμπτοι βραχίονες και στηρίγματα από υαλοίνες (fiberglass) για αντοχή.

Flexible fiberglass stretchers and fork brackets for durability



96 3900 1000 | BLACK

S.SERIES

# S.570 LARGE AUTOMATIC

Κωδικός : 95 5570



PREMIUM



STEEL



WARRANTY



WINDPROOF



100 km/h



Αξονας από ατσάλι σπαστός σε 2 μέρη / 2-part steelshaft  
Ακτίνες από ατσάλι σπαστές σε 2 μέρη α / 2-part steel rib



101 cm  
39.8 in



43 cm  
16.9 in



515 g  
18.17 oz



57 cm  
22.4 in



63 cm  
24.8 in



8 ακτίνες

8 ribs

Επιστροφή - Περιεχόμενα

Return to Index



Κάθε λαβή είναι μοναδική  
γυριστή λαβή χειροποίητη  
από ιταλικό ξύλο σφενδάμου.

Each handle is unique – crook  
handle hand-crafted from Italian  
maple wood



Πολύ σταθερή στον άνεμο  
χάρη στην εξαιρετικά ισχυρή  
ατσάλινη κατασκευή.

Very stable in wind thanks to extre-  
mely strong steel construction



Άνετη αποθήκευση χάρη στη  
θήκη με φερμουάρ

Comfortable stowage thanks to  
the zippered case

S.SERIES



95 5570 1000 | BLACK

S.570 LARGE AUTOMATIC

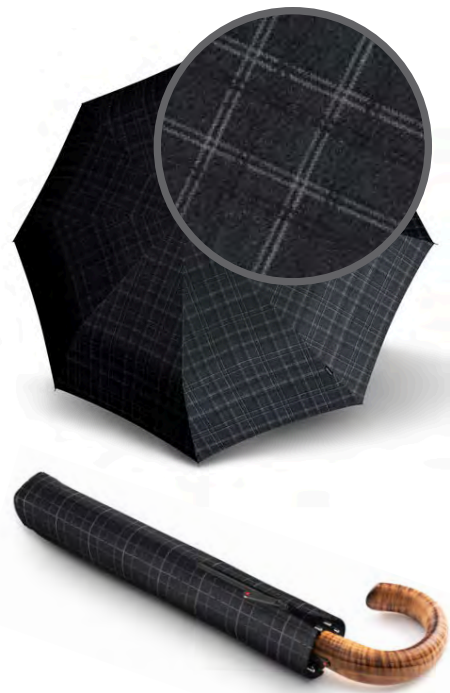

95 5570 7602  
MEN'S PRINTS CHECK



RE<sup>3</sup>

U.SERIES

T.SERIES

S.SERIES

A.SERIES

CONCEPT

POS

INFORMATION



S.SERIES

# S.770 LONG AUTOMATIC

Κωδικός : 96 5770 / 96 5771



PREMIUM



STEEL



WARRANTY



WINDPROOF



100 km/h



Αξονας από ατσάλι & ατσάλινες ακτίνες / Steel shaft and steel rib



109 cm  
42.9 in



91 cm  
35.8 in



625 g  
22.05 oz



63 cm  
24.8 in



80 cm  
31.5 in



10 ακτίνες

10 ribs

Επιστροφή - Περιεχόμενα

Return to Index



Κάθε λαβή είναι μοναδική γυριστή λαβή χειροποίητη από ιταλικό ξύλο σφενδάμου.

Each handle is unique – crook handle hand-crafted from Italian maple wood



Πολύ σταθερή στον άνεμο και ανθεκτική σε ανατροπές χάρη σε 10 εξαιρετικά ανθεκτικούς ασάλινους βραχίονες με ενίσχυση από υαλοΐνες (fiberglass).

Very stable in wind, extremely strong steel stretchers with fiberglass inlay ensure secure handling



Εκτενής θόλος σε μια κομψή ομπέλλα με κομψή θήκη για βέλτιστη προστασία

Expansive, elegant canopy; elegant sleeve for optimal protection

S.SERIES



96 5771 1000 | BLACK

S.770 LONG AUTOMATIC



96 5770 7602  
MEN'S PRINTS CHECK



RE3

U.SERIES

T.SERIES

S.SERIES

A.SERIES

CONCEPT

POS

INFORMATION

# VISION DUOMATIC



Αξονας σπαστός 3 μερών από ασάλι / 3-part shaft made of steel  
 Ακτίνες σπαστές σε 3 μέρη από αλουμίνιο & υαλονήματα / 3-part ribs made of aluminium and fiberglass  
 Λαβή ομπρέλλας & εξαρτήματα από Triflon / Handle and small parts made out of Triflon



Το Triflon® βιοδιασπώμενο βιοπλαστικό αντικαθιστά το κανονικό πλαστικό.  
 Triflon® biodegradable bioplastic replaces regular plastic



Θόλος από ανακυκλωμένο PET, επενδεδυμένη με αδιάβροχη επίστρωση χωρίς PFC από την ecorepel®

Canopy made of recycled PET, coated with PFC-free water and dirt repellent from ecorepel®



Συσκευασία φιλική προς το περιβάλλον  
 Environmentally friendly packaging

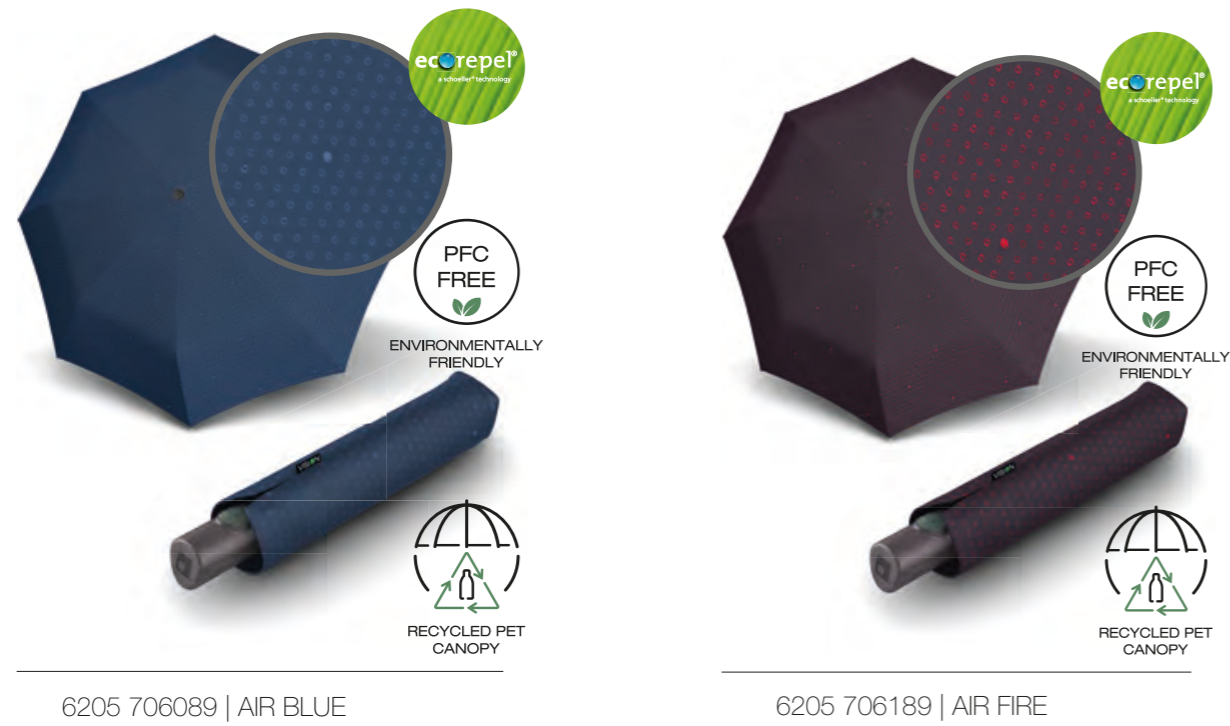
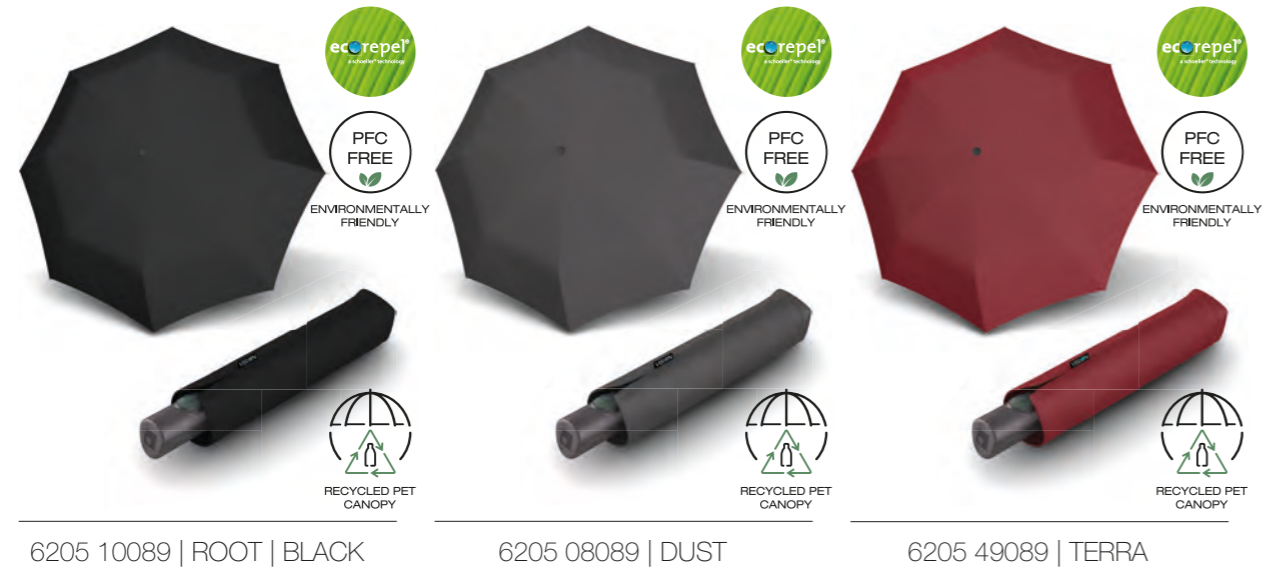

Vision display for 12 pcs. Vision umbrellas in their carton box



A.SERIES

# A.050 MEDIUM MANUAL

Κωδικός: 95 7051



WARRANTY



WINDPROOF



80 km/h



Αξονας σπαστός 3 μερών απο ασάλι / 3-part steelshaft

Ακτίνες σπαστές σε 3 μέρη από ασάλι & υαλονήματα / 3-part ribs made of steel and fibreglass



98 cm  
38.6 in



24 cm  
9.4 in



290 g  
10.23 oz



55 cm  
21.7 in



56 cm  
22.0 in



8 ακτίνες

8 ribs

Επιστροφή - Περιεχόμενα

Return to Index



Η Knirps για όλους,  
σε ελκυστική τιμή

The Knirps for all, at an attractive  
price



Χειροκίνητο εύκολο άνοιγμα

Easy manual opening



Μαύρος σπόρ σκελετός,  
δοκιμασμένος σε ταχύτητα  
ανέμου 80km/h σε  
αεροσήραγγα

Sporty frame in black; tested up to  
80 km/h in a wind tunnel

A.SERIES

A.050 MEDIUM MANUAL | NOS



95 7051 1000 | BLACK



95 7051 1201 | NAVY



95 7051 0800 | DARK GREY



95 7051 1502 | SALSA



95 7051 1701 | VIOLET



7050 1211 | BLUE



7051 8358 | PINTA CLASSIC



95 7051 8359 | PINTA SAILOR

RE<sup>3</sup>

U.SERIES

T.SERIES

S.SERIES

A.SERIES

CONCEPT

POS

INFORMATION



A.SERIES

A.050 MEDIUM MANUAL FASHION

RE<sup>3</sup>

U.SERIES

T.SERIES

S.SERIES

A.SERIES

CONCEPT

POS

INFORMATION



95 7051 8542 | CREATE BLACK



95 7051 8543 | CREATE CRYSTAL

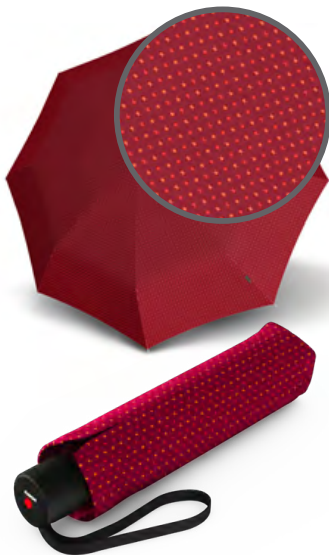

95 7051 8593 | JOY RED

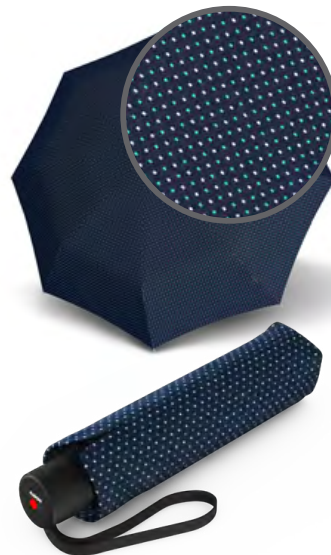

95 7051 8594 | JOY NAVY



95 7051 8691  
KOMBAT SAND



95 7051 8693  
KOMBAT NAVY





95 7051 8613 | ORGANIC  
MAGMA



95 7051 8614 | ORGANIC  
NEPTUNE



95 7051 8615 | ORGANIC  
MOON



95 7051 8616  
DOT ART LAVENDER



95 7051 8617  
DOT ART ALOE



95 7051 8618  
DOT ART OCEAN



# A.200 MEDIUM DUOMATIC

Κωδικός : 95 7201



WARRANTY



WINDPROOF



120 km/h



Αξονας μαύρος σπαστός 3 μερών απο ασάλι / black 3-part shaft made of steel

Ακτίνες σπαστές σε 3 μέρη από ασάλι & υαλονήματα / 3-part ribs made of steel and fibreglass



98 cm  
38.6 in



28 cm  
11.0 in



360 g  
12.7 oz



55 cm  
21.7 in



56 cm  
22.0 in



8 ακτίνες

8 ribs



Υψηλή σταθερότητα χάρη στον ανθεκτικό συνδυασμό υλικών από ατσάλι και υαλοΐνες (fiberglass), δοκιμασμένο σε αεροδυναμική σήραγγα μέχρι 120 χλμ/ώρα

Strong steel and fibreglass material mix ensures high stability, tested up to 120 km/h in a wind tunnel



Βέλτιστη σχέση ποιότητας-τιμής με απλό σχεδιασμό

Optimal value for money with sleek design



Άνετο, αυτόματο άνοιγμα και κλείσιμο με μεγάλο κουμπί; σπόρ κατασκευή σε μαύρο χρώμα

Pleasant automatic opening and closing motion with large push-button; sporty frame in black

A.SERIES

A.200 MEDIUM DUOMATIC | NOS



95 7201 1000 | BLACK



95 7201 1201 | NAVY



95 7201 0800 | DARK GREY



95 7201 1502 | SALSA



95 7201 1701 | VIOLET



95 7201 8610 | PRIDE

RE<sup>3</sup>

U.SERIES

T.SERIES

S.SERIES

A.SERIES

CONCEPT

POS

INFORMATION



A.SERIES

A.200 MEDIUM DUOMATIC | NOS & FASHION

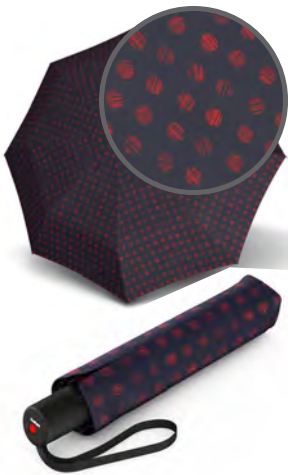

95 7201 8359 | PINTA SAILOR



95 7201 8593 | JOY RED

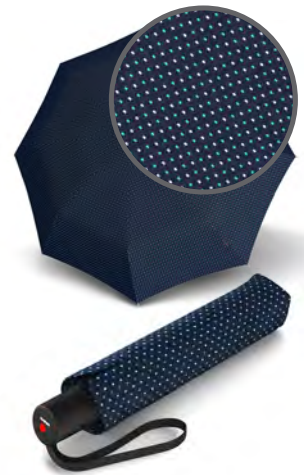

95 7201 8594 | JOY NAVY



95 7201 9910  
TRANSPARENT BLACK



95 7201 8613  
ORGANIC MAGMA



95 7201 8614  
ORGANIC NEPTUNE



95 7201 8615  
ORGANIC MOON

RE<sup>3</sup>

U.SERIES

T.SERIES

S.SERIES

A.SERIES

CONCEPT

POS

INFORMATION



95 7201 8616  
DOT ART LAVENDER



95 7201 8617  
DOT ART ALOE



95 7201 8618  
DOT ART OCEAN



95 7201 8691  
KOMBAT SAND



95 7201 8693  
KOMBAT NAVY



95 7201 8794  
FOUNTAIN EARTH

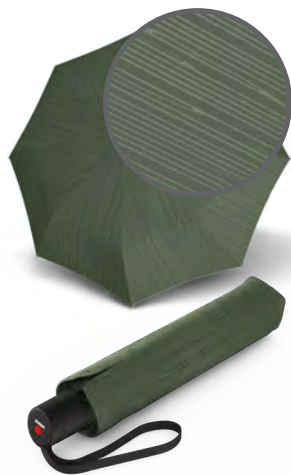

95 7201 8795  
FOUNTAIN OLIV



A.SERIES

A.200 MEDIUM DUOMATIC | FASHION



NEW

95 7201 8838 | CONE BLACK



NEW

95 7201 8836 | IMAGINE



NEW

95 7201 8837 | FAIRYBLOOM

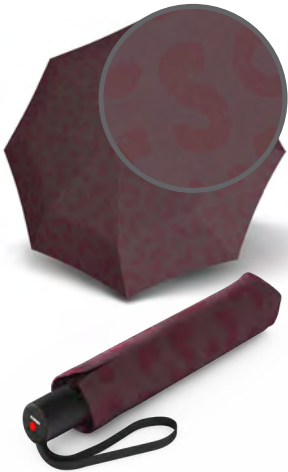

NEW

95 7201 8839 | CONE BORDEAUX



NEW

95 7201 8840 | CONE NAVY



RE3

U.SERIES

T.SERIES

S.SERIES

A.SERIES

CONCEPT

POS

INFORMATION



A.SERIES

# A.400 XXL DUOMATIC

Κωδικός: 95 7400



WARRANTY



WINDPROOF



100 km/h



Σπαστός άξονας σε 3 μέρη από ασάλι / 3-part steel shaft

Ακτίνες σπαστές σε 3 μέρη από ασταλι & υαλονήματα / 3-part ribs made of steel and fibreglass



126 cm  
49.6 in



38 cm  
15 in



510 g  
17.99 oz



70 cm  
27.6 in



75 cm  
29.5 in



8 Schienen  
8 ribs

Επιστροφή - Περιεχόμενα

Return to Index



Η μεγαλύτερη σπαστή ομπρέλα της Knipps με αυτόματο μηχανισμό ανοίγματος & κλεισίματος σε μορφή XXL

Largest Duomatic pocket umbrella in XXL format



Υψηλή σταθερότητα χάρη στον ανθεκτικό συνδυασμό υλικών από ατσάλι και υαλοΐνες (fiberglass)

Strong steel and fibreglass material mix ensures high stability



95 7400 1000 | BLACK



95 7400 1201 | NAVY

# A.405 XXL DUOMATIC VENTED

Κωδικός : 95 7405



WARRANTY



WINDPROOF



100 km/h



Σπαστός άξονας σε 3 μέρη από ασάλι / 3-part steel shaft

Ακτίνες σπαστές σε 3 μέρη από ασβηστό & υαλονημάτα / 3-part ribs made of steel and fibreglass



126 cm  
49.6 in



38 cm  
15 in



520 g  
18.34 oz



70 cm  
27.6 in



75 cm  
29.5 in



8 Schienen  
8 ribs

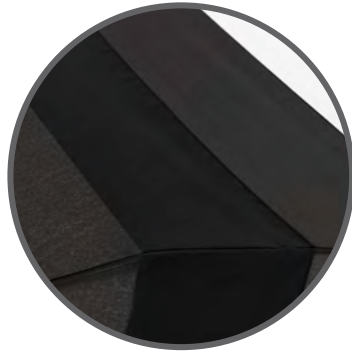

Υπερμεγέθης θόλος με αεραγωγούς για πιο σταθερό κράτημα της ομπρέλας

Oversized roof with wind valve for stable umbrella position



Υψηλή σταθερότητα χάρη στον ανθεκτικό συνδυασμό υλικών από ατσάλι και υαλοϋίνες (fiberglass)

Strong steel and fibreglass material mix ensures high stability

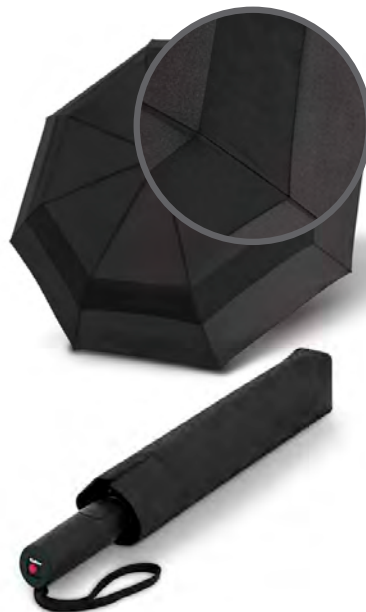

95 7405 1000 | BLACK

A.SERIES

# A.760 STICK AUTOMATIC

Κωδικός : 96 7760 / 96 7761 (Μοντέλλο με διαφορετική λαβή / Follow-up article with new handle design)



WARRANTY



WINDPROOF



120 km/h



96 7760 / 96 7761

Ατσάλινος σκελετός με ακτίνες απο υαλονήματα / Steel shaft with fibreglas ribs



102 cm  
40.2 in



87 cm  
34.3 in



380 g  
13.4 oz



61 cm  
24.0 in



77 cm  
30.3 in



8 Schienen  
8 ribs

Επιστροφή - Περιεχόμενα

Return to Index



Μεγάλο κουμπί ενεργοποίησης για μεγαλύτερη άνεση στη λειτουργία

Large release button for optimal comfort



Μια Knirps για όλους σε μια πολύ ελκυστική τιμή

The Knirps for all, at an attractive price



Στρογγυλεμένες γωνίες στο τελείωμα των ακτίνων για αποφυγή ατυχημάτων

Rounded tips for more safety





96 7761 1000 | BLACK



96 7760 1211 | BLUE



96 7760 1341 | PACIFIC



96 7761 8616  
DOT ART LAVENDER



96 7761 8617  
DOT ART ALOE



96 7761 8618  
DOT ART OCEAN

RE3

U.SERIES

T.SERIES

S.SERIES

A.SERIES

CONCEPT

POS

INFORMATION

A.SERIES

# A.771 LONG AUTOMATIC

Κωδικός : 96 7771



WARRANTY



WINDPROOF



Ατσάλινος σκελετός με ακτίνες απο υαλονήματα / steel shaft and fibreglass ribs  
Ακτίνες απο ατσάλι & υαλονήματα / ribs made of steel and fibreglass



104 cm  
40.9 in



87 cm  
34.3 in



490 g  
17.28 oz



61 cm  
24.0 in



77 cm  
30.3 in



10 Schienen  
10 ribs

Επιστροφή - Περιεχόμενα

Return to Index



Γυριστή λαβή από αληθινό  
ξύλο σφενδάμου

Crook handle made of real maple  
wood



Ανθεκτική κατασκευή με δοκιμασμένο  
ατσάλινο σκελετό και ακτίνες από  
ελαφρύ και ευκαμπτο fiberglass

robust construction with proven  
steel pole and rails made of light  
and flexible fiberglass



Το μεγάλο κουμπί ενεργοποίησης  
προσφέρει άνετη χρήση

Large release button for optimal  
comfort



96 7771 1000 | BLACK



96 7771 1201 | NAVY



CONCEPT

# C.760 STICK TRANSPARENT

Κωδικός : 96 8760



WARRANTY



WINDPROOF



100 km/h



Ατσάλινος σκελετός και ακτίνες απο υαλονήματα / Steel shaft and fibreglass rib



88 cm  
34.6 in



87 cm  
34.3 in



375 g  
13.23 oz



61 cm  
24.0 in



76 cm  
29.9 in



8 Schienen  
8 ribs

Επιστροφή - Περιεχόμενα

Return to Index



Διαφανής ομπρέλα σε σχήμα καμπάνας. Κομψή ταινία περιμετρικά και κλείσιμο από ύφασμα

Transparent umbrella with dome shape; elegant fabric binding and closing band



Ομπρέλα με μηχανισμό χειροκίνητου ανοίγματος και μοντέρνα λαβή από ακρυλικό γυαλί

Umbrella with manual opening mechanism and stylish acrylic glass handle



96 8760 1000 | TRANSPARENT SOLID BLACK



96 8760 8541 | PLAY



96 8760 8697 | LILITH



96 8760 8609 | PRIDE

FASHION FASHION FASHION

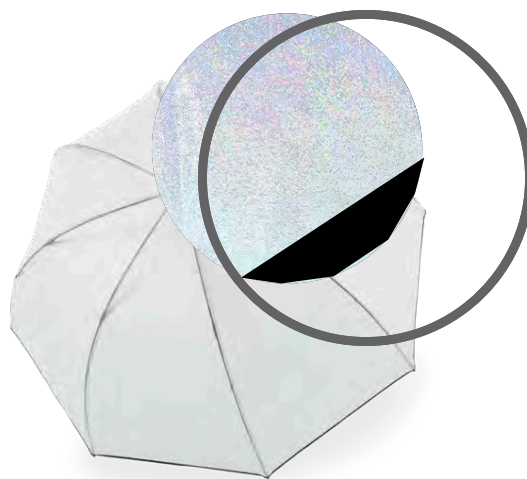
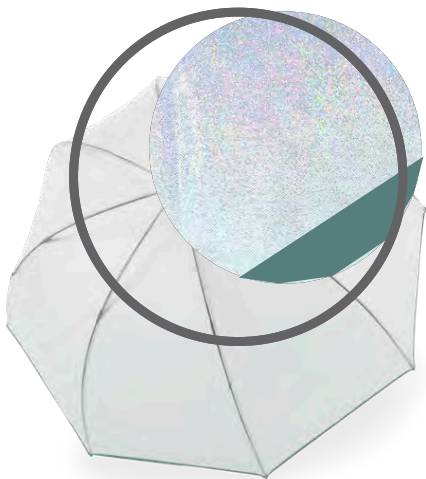

FASHI  
ON

96 8760 8811 | STARDUST  
AGAVE

FASHI  
ON

96 8760 8812 | STARDUST  
BLACK

CONCEPT

# 6010 X1

Κωδικός: 95 6010



WARRANTY

80 km/h

OEKO-TEX®  
CONFIDENCE IN TEXTILES  
STANDARD 100

designers institute  
of new zealand  
design awards

BEST

IDSA.

GOOD  
DESIGN



Αξονας σπαστός 5 μερών από αλουμίνιο / 5-part aluminium shaft

Ακτίνες σπαστές σε 4 μέρη από αλουμίνιο, ατσάλι και υαλονήματα / 4-part ribs made of aluminium, steel and fiberglass



90 cm  
35.4 in



incl. Case  
18 cm  
7.1 in



incl. Case\*  
290 g  
10.23 oz



52 cm  
20.5 in



53 cm  
20.9 in



7 ribs

χωρίς θήκη 234g / without Case 234 g / 8.25 oz

INFORMATION

POS

CONCEPT

A.SERIES

S.SERIES

T.SERIES

U.SERIES

RE



CONCEPT

6010 X1 | FASHION

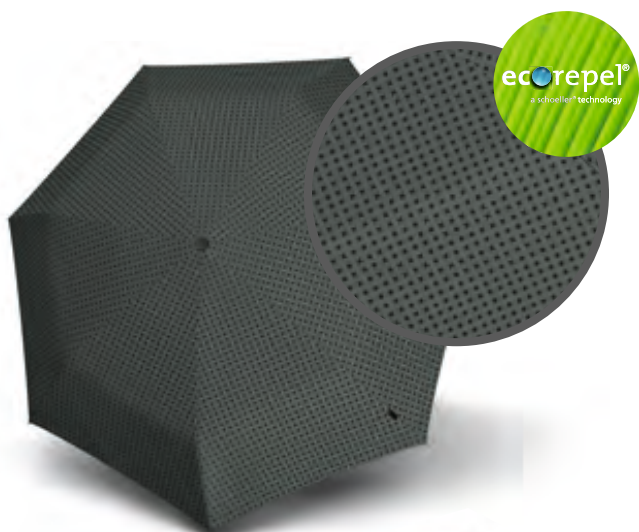

95 6010 8483 | STONE

95 6010 8510 | GOLD



GLAM

6010 8575 | GLAM NAVY

6010 8576 | GLAM RED

RE<sup>3</sup>

U.SERIES

T.SERIES

S.SERIES

A.SERIES

CONCEPT

POS

INFORMATION

# UMBRELLA2GOFLEX

Κωδικός: 8821000



WARRANTY



Μαύρο με κομψό σχέδιο σιλικόνης.

Black with elegant silicone print

Διπλωμένες άκρες που σχηματίζουν δύο δακτύλιους, για ασφαλή και εύκολη μεταφορά της ομπρέλας σας – κατάλληλο για ομπρέλες τσέπης και μακριές ομπρέλες, αξεσουάρ που στην κυριολεξία **"σας λύνει τα χέρια!"**

Ends folded to hold an umbrella in-side – suitable for folding umbrellas and long umbrellas



8821000 | BLACK

100% Πολυεστέρας / 100% polyester





## Επισκόπηση μοντέλων | PRODUCT OVERVIEW



LONGLIFE

Για να μπορεί η ομπρέλα Knirps σας να σας προσφέρει αξιόπιστη προστασία για πολλά χρόνια, θα πρέπει να την αφήνετε ανοιχτή να στεγνώσει μετά από κάθε χρήση. Μόνο όταν έχει εξαφανιστεί κάθε υγρασία, πρέπει να διπλώνετε ξανά την ομπρέλα και να την αποθηκεύετε στη θήκη της.

In order for your Knirps umbrella to be a trusty companion offering cover for many years, it should be opened for complete drying after each use. Only when all moisture has evaporated should the umbrella be folded closed and stored in its case.

### Επισκόπηση / OVERVIEW



























	Vorschau preview	Name name	Seite page	Funktion function
RE <sup>3</sup>		X4U	5	
U.SERIES		US.050	8	
		U.200	13	
		U.090	18	
T.SERIES		U.900	21	
		T.020	24	
		T.200	27	
		T.260	34	
		T.400	37	
		T.760	41	
		T.771	46	
		T.900	50	

### Χαρακτηριστικά / SPECIFICATIONS

90 cm 35.4 in	115 g 4.06 oz	21 cm 8.3 in	6 Schienen 6 ribs	49 cm 19.3 in	48 cm 18.9 in
90 cm 35.4 in	115 g 4.06 oz	21 cm 8.3 in	6 Schienen 6 ribs	49 cm 19.3 in	48 cm 18.9 in
95 cm 37.4 in	180 g 6.35 oz	27 cm 10.6 in	6 Schienen 6 ribs	54 cm 21.3 in	53 cm 20.9 in
126 cm 49.6 in	295 g 10.41 oz	38 cm 15 in	8 Schienen 8 ribs	69 cm 27.2 in	76 cm 29.9 in
133 cm 52.4 in	245 g 8.64 oz	97 cm 38.2 in	8 Schienen 8 ribs	74 cm 29.1 in	90 cm 35.4 in
94 cm 37.0 in	245 g 8.64 oz	19 cm 7.5 in	7 Schienen 7 ribs	51 cm 20.1 in	51 cm 20.1 in
97 cm 38.2 in	330 g 11.64 oz	28 cm 11.0 in	8 Schienen 8 ribs	54 cm 21.3 in	55 cm 21.7 in
96 cm 37.8 in	400 g 14.11 oz	32 cm 12.6 in	8 Schienen 8 ribs	54 cm 21.3 in	59 cm 23.2 in
115 cm 45.3 in	590 g 20.81 oz	35 cm 13.8 in	8 Schienen 8 ribs	64 cm 25.2 in	70 cm 27.6 in
105 cm 41.3 in	460 g 16.23 oz	88 cm 34.6 in	8 Schienen 8 ribs	60 cm 23.6 in	77 cm 30.3 in
111 cm 43.7 in	590 g 20.81 oz	90 cm 35.4 in	10 Schienen 10 ribs	63 cm 24.8 in	81 cm 31.9 in
120 cm 47.2 in	680 g 23.99 oz	95 cm 37.4 in	8 Schienen 8 ribs	69 cm 27.1 in	85 cm 33.5 in

Επισκόπηση / OVERVIEW

Χαρακτηριστικά / SPECIFICATIONS

	Vorschau preview	Name name	Seite page	Funktion function	 XX cm	 XXX g	 XX cm	 8	 XX cm	 XX cm
S.SERIES		S.570	52	 AUTOMATIC	101 cm 39.8 in	515 g 18.17 oz	43 cm 16.9 in	8 Schienen 8 ribs	57 cm 22.4 in	63 cm 24.8 in
		S.770	55	 AUTOMATIC	109 cm 42.9 in	625 g 22.05 oz	91 cm 35.8 in	10 Schienen 10 ribs	63 cm 24.8 in	80 cm 31.5 in
A.SERIES		A.050	60	 MANUAL	98 cm 38.6 in	290 g 10.23 oz	24 cm 9.4 in	8 Schienen 8 ribs	55 cm 21.7 in	56 cm 22.0 in
		A.200	66	 DUOMATIC	98 cm 38.6 in	360 g 12.7 oz	28 cm 11.0 in	8 Schienen 8 ribs	55 cm 21.7 in	56 cm 22.0 in
		A.400	73	 DUOMATIC	126 cm 49.6 in	510 g 17.99 oz	38 cm 15 in	8 Schienen 8 ribs	70 cm 27.6 in	75 cm 29.5 in
		A.405	75	 DUOMATIC	126 cm 49.6 in	520 g 18.34 oz	38 cm 15 in	8 Schienen 8 ribs	70 cm 27.6 in	75 cm 29.5 in
		A.760	77	 AUTOMATIC	102 cm 40.2 in	380 g 13.4 oz	87 cm 34.3 in	8 Schienen 8 ribs	61 cm 24.0 in	77 cm 30.3 in
		A.771	80	 AUTOMATIC	104 cm 40.9 in	490 g 17.28 oz	87 cm 34.3 in	10 Schienen 10 ribs	61 cm 24 in	77 cm 30.3 in
CONCEPT		6010	86	 MANUAL	90 cm 35.4 in	290 g 10.23 oz	18 cm 7.1 in	7 Schienen 7 ribs	52 cm 20.5 in	53 cm 20.9 in
		C.760	83	 MANUAL	88 cm 34.6 in	375 g 13.23 oz	87 cm 34.3 in	8 Schienen 8 ribs	61 cm 24 in	76 cm 29.9 in
		Umbrella2GoFlex	108		180 cm 70.87 in					3 cm 1.18 in

RE<sup>3</sup>

U.SERIES

T.SERIES

S.SERIES

A.SERIES

CONCEPT

POS

INFORMATION



### WINDPROOF

Για να αποφευχθεί ζημιά στην ομπρέλα, το πανί διπλώνει κατά τη διάρκεια δυσμενών καιρικών συνθηκών χάρη στις εξαιρετικά ευέλικτες ακτίνες, χωρίς να τις σπάει.

To avoid damage to the umbrella, the canopy folds over during unfavorable weather conditions thanks to highly flexible ribs, without breaking them.



### WINDTUNNEL

Τα προϊόντα Knirps δοκιμάζονται τακτικά σε αεροσήραγγα για να ελεγχθεί η ανθεκτικότητά τους.

Knirps products are wind tunnel tested on a regular basis to check their sturdiness.



### PREMIUM QUALITY

Αυτά τα μοντέλα είναι εξοπλισμένα με υψηλής ποιότητας εξαρτήματα:

- Αλουμίνιο αεροπορικής ποιότητας – ελαφρύ, ανθεκτικό και ανοξείδωτο
- Ειδική επίστρωση – ύφασμα που στεγνώνει γρήγορα
- Πλαστικά υψηλής ποιότητας – προϊόντα μεγάλης διάρκειας ζωής

The models are equipped with high quality components:

- Air craft quality aluminum – light, robust and stainless
- Special coating – quick drying fabric
- High-quality plastics – long life products



### STEEL COMPONENT

Τα ατσάλινα εξαρτήματα κάνουν την ομπρέλα ανθεκτική, αντοχής και εξαιρετικά ανθεκτική στον άνεμο, διπλώνοντας μόνο σε εξαιρετικά υψηλές ταχύτητες ανέμου.

Steel components make the umbrella robust, durable and extremely wind resistant, only folding over during particularly high wind speeds.



### CARBOFLEX

Η Knirps χρησιμοποιεί την τεχνολογία CarboFlex® σε επιλεγμένα μέρη, τα οποία είναι εξ ολοκλήρου κατασκευασμένα από ανθρακόνημα. Αυτή η τεχνολογία καθιστά την ομπρέλα εξαιρετικά ευέλικτη και επιπλέον μειώνει το βάρος της.

Knirps uses the CarboFlex® technology in select parts which are fully made of carbon. This technology makes the umbrella extremely flexible and additionally reduces its weight.



### HANDLE MADE IN GERMANY

Η κυρτή λαβή από ιταλικό ξύλο σφενδάμου είναι χειροποίητη στη Γερμανία - κάθε λαβή είναι μοναδική

The crook handle made of Italian maple wood is handmade in Germany - each handle is unique.

WOOD



UV95IUPF50

## UV PROTECTION

Εξαιρετική προστασία από τη βροχή και τον ήλιο. Μπλοκάρει τουλάχιστον το 95% των ακτίνων UVA και το 98% των ακτίνων UVB. Δοκιμασμένο σύμφωνα με το Αυστραλιανό/Νεοζηλανδικό πρότυπο AS/NZS 4033:2017.

Outstanding protection from rain and sun. Blocks at least 95% of UVA and 98% of UVB rays. Tested in accordance with Australia/New Zealand norm AS/NZS 4033:2017

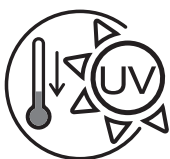

HEATSHIELD

## HEAT SHIELD

Χάρη στην εσωτερική επίστρωση, οι ομπρέλες προσφέρουν μέγιστη προστασία από την υπεριώδη ακτινοβολία (UV) με επιπλέον προστασία από τη θερμότητα, καθώς η θερμοκρασία κάτω από την τέντα μειώνεται έως και κατά 40%. Το Heat Shield μπλοκάρει πάνω από το 99,95% των ακτίνων UVA και παρέχει εξαιρετική αντηλιακή προστασία με SPF / UPF 50+.

Thanks to the coating on the inside, the umbrellas offer maximum UV protection with additional heat protection, as the temperature under the canopy is reduced by up to 40%. The Heat Shield blocks more than 99.95% of UVA rays and has excellent sun protection at SPF / UPF 50+.



DUOMATIC

## DUOMATIC

Πατήστε το κουμπί, κλείστε την ομπρέλα και ανοίξτε την ξανά. Το πανί ανοίγει κανονικά και σας προστατεύει αξιόπιστα από τη βροχή.

Push the button, close the umbrella and open it up again. The canopy opens as usual and protects you reliably from rain.

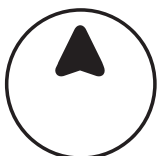

AUTOMATIC

## AUTOMATIC

Πατήστε το κουμπί και η ομπρέλα ανοίγει αυτόματα για βέλτιστη προστασία από τη βροχή. Μετά τη χρήση, τραβήξτε τον μηχανισμό προς τα κάτω και το πανί θα διπλώσει ξανά στη σωστή θέση.

Push the button and the umbrella opens automatically for optimal protection from the rain. After usage pull the runner downwards and the canopy will fold back into the correct position.



MANUAL

## MANUAL

Τραβήξτε τον μηχανισμό προς τα κάτω και το πανί θα διπλωθεί αυτόματα στη σωστή θέση, αφήνοντας την ομπρέλα έτοιμη προς χρήση για την επόμενη βροχή.

Pull the runner downwards and the canopy will automatically fold back into the correct position, leaving the umbrella ready for use during the next rain shower.



### REFLECTIVE

Το πανί της ομπρέλας είναι εξοπλισμένο με λωρίδα ανακλαστήρα και η θήκη της ομπρέλας διαθέτει επίσης ανακλαστικά στοιχεία – έτσι η ομπρέλα εξασφαλίζει βέλτιστη ασφάλεια ακόμα και όταν είναι κλειστή κατά τη διάρκεια της βροχής.

The canopy is equipped with a reflective strip and the umbrella cover has reflective elements as well – it ensures optimal visibility in the rain.



### REVERSE CLOSING

Η Re<sup>3</sup> είναι εξοπλισμένη με τη δοκιμασμένη λειτουργία Duomatic, αλλά με έναν αντίστροφο μηχανισμό κλεισίματος. Αυτό επιτρέπει την είσοδο στο αυτοκίνητο χωρίς να βραχείτε.

The Re<sup>3</sup> is equipped with the trusted Duomatic function and a reverse closing mechanism. This novel feature keeps you dry when stepping into a car.



### RESISTS WIND

Η ειδική κατασκευή προσφέρει βελτιωμένη αντοχή σε σχέση με τους συμβατικούς τύπους σπαστών ομπρελών, όσον αφορά το αναποδογύρισμα του πανιού. Εάν η ομπρέλα αναποδογυρίσει, μπορεί εύκολα να ξαναανοιχτεί με το πάτημα ενός κουμπιού.

The unique design offers an enhanced flip-over resistance, far surpassing traditional pocket umbrellas. And if it does flip? The Re<sup>3</sup> effortlessly rights itself at the press of the Duomatic button.

### RECYCLED MATERIALS



Η λαβή αναπτύχθηκε σε συνεργασία με την Circular Materials από τη Γερμανία και αποτελείται από ανακυκλωμένα υφασμάτινα νήματα. Το ύφασμα του πανιού είναι κατασκευασμένο από 100% rPET, πιστοποιημένο από GRS και OEKO-TEX® STANDARD 100.

The handle was developed in collaboration with Circular Materials from Germany and consists of recycled textile fibers. The canopy fabric is made of 100 % rPET, certified by GRS and OEKO-TEX® STANDARD 100.





## RECYCLED PET

Το πανί είναι κατασκευασμένο από ανακυκλωμένο PET. Περίπου τέσσερις πλαστικές φιάλες των 0,5 λίτρων μπορούν να ξαναχρησιμοποιηθούν για μια ομπρέλα.

The canopy is made from recycled PET. Approximately four 0,5 l plastic bottles can be reutilized for one umbrella.



## ΟΕΚΟ-ΤΕΧ®

Το ΟΕΚΟ-ΤΕΧ® STANDARD 100 είναι ένα σήμα για υφάσματα που έχουν ελεγχθεί για επιβλαβείς ουσίες. Θέτει τα πρότυπα για την ασφάλεια των υφασμάτων, από το νήμα μέχρι το τελικό προϊόν. Κάθε αντικείμενο που φέρει το σήμα STANDARD 100 πιστοποιείται ότι έχει περάσει τις δοκιμές ασφαλείας για την παρουσία επιβλαβών ουσιών.

OEKO-TEX® STANDARD 100 is a label for textiles tested for harmful sub-stances. It sets the benchmark for textile safety, from yarn to finished product. Every item bearing the STANDARD 100 label is certified as having passed safety tests for the presence of harmful substances.



## 100% WOOD

Κάθε λαβή είναι μοναδική – προσεκτικά κατασκευασμένη από 100% υψηλής ποιότητας ξύλο σφενδάμου. Τα φυσικά νερά του ξύλου χαρίζουν σε κάθε κομμάτι τον δικό του ξεχωριστό χαρακτήρα, κάνοντάς το πραγματικά ιδιαίτερο.

Each handle is unique – carefully crafted from 100% premium maple wood. The natural grain of the wood gives every item its own distinct character, making it truly special.



**AUSTRALIEN**

Sydney Umbrellas  
13 Cradle Close  
Beaumont Hills  
2155 NSW  
Australia  
Web: www.sydneyumbrellas.com.au  
sales@sydneyumbrellas.com.au

**AUSTRIA**

DOPPLER, E. Doppler & Co GmbH  
Schloßstraße 24  
5280 Braunau am Inn  
Ph: +43 (0)7722 63205 4306  
Fax: +43 (0)7722 63205 94306  
umbrella@dopplerschirme.com

**BELGIUM & LUXEMBOURG**

Showroom Trade Mart Brussels  
Birmingham 449  
Atomiumsquare 1  
1020 Brussel  
Ph: +32 475 96 56 97  
pascalle@tamaris-bags.be

**CANADA**

HOLIDAY GROUP  
4875, boul. Des Grandes Prairies Montréal, Québec,  
Canada H1R 1X4 Ph: +1 (0)514 325 0665 403 Fax:  
+1 (0)514 325 4259  
holiday@holiday.ca

**CHINA**

KNIRPS (XIAMEN) TRAVELWEARS CO. LTD.  
Room 1603-1, C05 Building  
No. 63, ShanWei Road  
Xiamen Software Park Phase 3. 361000  
Xiamen, China  
Ph: +86 (0)592 628 5446  
Fax: +86 (0)592 628 5445  
info@knirps.cn

**COLOMBIA**

Estibol SAS  
Carrera 12 # 89-28 PISO 3  
110221 Bogotá Colombia  
Phone: 5802305 Fax: N/A  
E-mail: camilo.reina@estibol.com

**DENMARK**

SCANDINAVIAN TRAVEL INNOVATION AB  
Stora Ävägen 1  
436 34 Askim Sweden  
Ph: +46 (0)31 749 24 00  
Fax: +46 (0)31 749 24 99  
info@travelinnovation.se

**FRANCE**

GUY DE JEAN  
Usine de la Croix d'Amay  
58220 Donzy  
France  
Ph: +33 (0)3 86 39 31 81  
Fax: +33 (0)3 86 39 30 47  
contact@guydejean.com

**GERMANY**

DOPPLER, H. Würlingsdöbler GmbH  
A.Kolpingstrasse 3  
84359 Simbach am Inn  
Ph: +49 (0)8571 91 22 4306  
Fax: +49 (0)8571 91 22 94306  
umbrella@dopplerschirme.com

**GREECE**

TRAVEL INTERNATIONAL BRANDS LP.  
Ivis 8  
15124 Marousi  
Ph: + 30 210 3219 545  
info@travelbrands.gr

**HONG KONG**

5PM Distribution Company United  
Rm B06, 10/f, Shing King  
Industrial Building, 45 Kut Shing Street  
HongKong  
info@5pm.com.hk

**INDIA**

Sunglass Palace Pvt.Ltd  
129G/64 NSEZ Dadri road Phase-II Noida Uttar  
Pradesh  
201305 India  
Ph: +91 120 4359711  
Fax: +91 120 4359714  
arun@sgpl-beyondluxury.com

**ITALY**

GREEN SRL Unipersonale  
Via 4 Novembre, 19  
22029 Ugghiate Trevano (CO)  
Ph: +39 (0)522 160 64 95  
info@green-italia.it

**JAPAN**

IMAO CORPORATION  
2002, Senbiki, Seki  
Gifu 501-3954  
Ph: +81 (0)575 28 5823  
Fax: +81 (0)575 27 0012  
info@imao.jp

**NETHERLANDS**

DOPPLER, E. Doppler & Co GmbH  
Schloßstraße 24  
5280 Braunau-Ranshofen  
Rianne Vlierman  
Ph. +31 624167157  
info@dameduton.nl

**NORWAY**

SCANDINAVIAN TRAVEL INNOVATION AB  
Stora Ävägen 1  
436 34 Askim  
Sweden  
Ph: +46 (0)31 749 24 00  
Fax: +46 (0)31 749 24 99  
info@travelinnovation.se

**PANAMA**

Rembach S.A.  
PH Parque Urraca  
Unit#6A  
Calle 45 y Federico Boyd, Bella Vista  
Panama  
Republic of Panama  
Ph: +507 (0)6674 8377  
Fax: +507 (0)203 2525  
ventas@rembach.com

**PHILIPPINES**

Thinklibrary Inc.  
Unit 202A Captain Roja St.  
San Juan, Metro Manila  
Philippines 1500  
Ph: +63 (0)917 805 53 48  
fernandezhk@urbantravellerco.com

**PORTUGAL**

MALAS PEIXOTO SOARES, LDA.  
Rua Carlos D. Caneças, 18-A  
2700-163 Amadora  
Ph: +351 (0)214 989 740  
Fax: +351 (0)214 89 749  
info@mps.pt

**RUSSIA**

Individual Entrepreneur  
Vyborgskaya nab. 29  
197341, Saint-Petersburg  
Ph 1: +7 (0)812 603 78 41  
Ph 2: +7 (0)495 108 06 03  
info@knirps-shop.ru

**SINGAPORE**

Seager Inc. Private Limited  
No. 9 Tai Seng Link  
Lee King Hwa  
Building 534053  
Singapore  
khersze.wang@seager.  
com.sg

**SOUTH KOREA**

SEVOKOREA CO.,LTD.  
4F LEE&Co Design Center,  
63-90 Pokpo-ro 17gil,  
Hwado-eup, Namyangju-si,  
12182 Gyeonggi-do Korea  
Ph: +82 (0)31 559 00 76  
Fax: +82 (0)31 559 89 49  
info@sevokorea.com

**SPAIN**

Distribuciones MÁrquez  
AN3 SL C/ Edison, 11  
P.I. Llanos de Jarata  
Montilla CP  
14550 Córdoba  
Ph: +34 (0)957 650 428  
info@paraguasdoppler.es

**SWEDEN**

SCANDINAVIAN TRAVEL INNOVATION AB  
Stora Ävägen 1  
436 34 Askim  
Sweden  
Ph: +46 (0)31 749 24 00  
Fax: +46 (0)31 749 24 99  
info@travelinnovation.se

**SWITZERLAND**

STROTZ AG  
Herrenackerstraße 16  
8730 Uznach  
Ph: +41 (0)55 285 97 00  
Fax: +41 (0)55 285 97 09  
info@strotz.ch

**TAIWAN**

IUMBRELLA INTERNATIONAL  
MARKETING CO.,LTD  
No. 356-8, Baozhong Rd., Xinpu  
Township 305 Hsinchu County  
Republic of China (Taiwan)  
Ph: +886 (0)3 551 53 50  
Fax: +886 (0)3 551 552 50  
i.umbrella.tw@gmail.com

**THAILAND**

NOTE SOUND & LIGHT CO.,LTD.  
209 Soi Bureerom4, Charoenkrung  
Rd. Banbart, Pomprabsatrupai  
Thailand  
chutipass.s@dksh.com

**UKRAINE**

Macroline LTD  
12/16 Radishcheva str  
03680 Kyiv  
Ukraine  
Ph: +38 0444 952 262  
mpt@attribute.ua

**USA**

The Lion Group US  
3069 Lawson Blvd  
Oceanside NY 11572  
USA  
jay@theliongroup.net

**UK**

Burton Blake Ltd  
Unit 7 Hangdown Mead Business Park  
GB RH19 4HU Sharthorne  
sales@burtonblake.co.uk

98

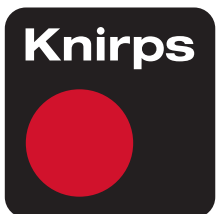

YEARS  
ANNIVERSARY

